

Fundo Top

für Fundo Riolito neo | for Fundo Riolito neo | pour Fundo Riolito neo

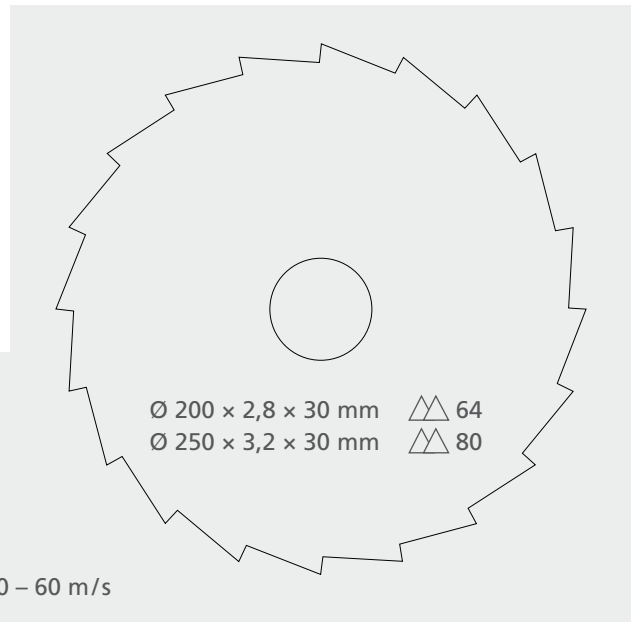

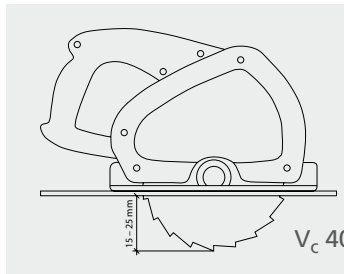
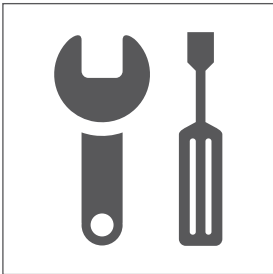
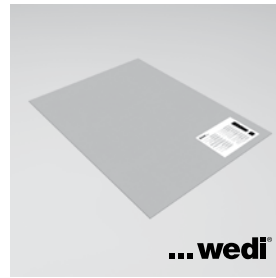
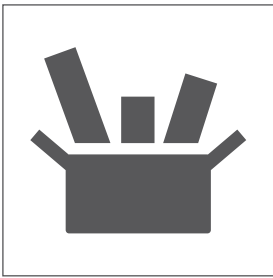

wedi 610

La bonne épaisseur de cordon de mastic polymère wedi 610 :
pour cela, couper la canule de cartouche à 25 mm de son extrémité.

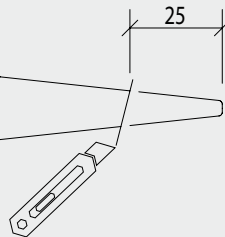
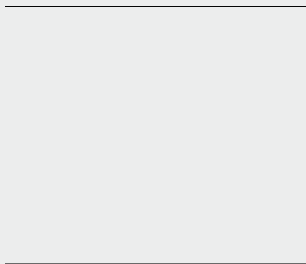

Fundo Riolito neo

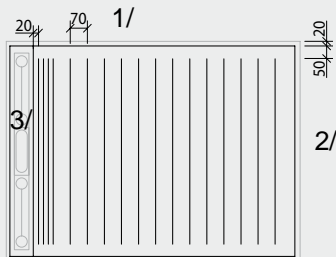

Fundo Riolito neo

1.200 x 900 mm

2,2 x wedi 610

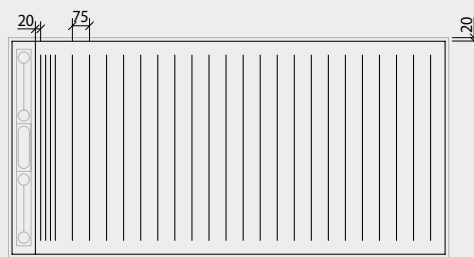

Fundo Riolito neo

1.800 x 900 mm

3,1 x wedi 610

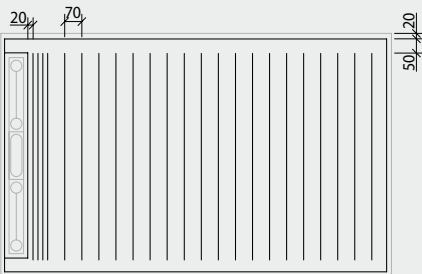

Fundo Riolito neo

1.600 x 1.000 mm

3,2 x wedi 610

1/ Un contour parfaitement fermé au mastic polymère wedi 610 :
- au périmètre du Fundo Riolito neo Top à 20 mm des bords
- autour du cadre de canal à 20 mm des bords.

2/ Lignes parallèles de mastic wedi 610 séparées de 70 mm
et stoppées à 70 mm à leur extrémité des bords latéraux
du Fundo Riolito neo Top : pour laisser l'air s'échapper
lors du collage.

3/ Un collage renforcé devant le caniveau :
- 4 lignes de mastic polymère wedi 610 espacées de 20 mm
devant le cadre de canal
- lignes stoppées à 70 mm à leur extrémité des bords latéraux
du Fundo Riolito neo Top : pour laisser s'échapper l'air
lors du collage.

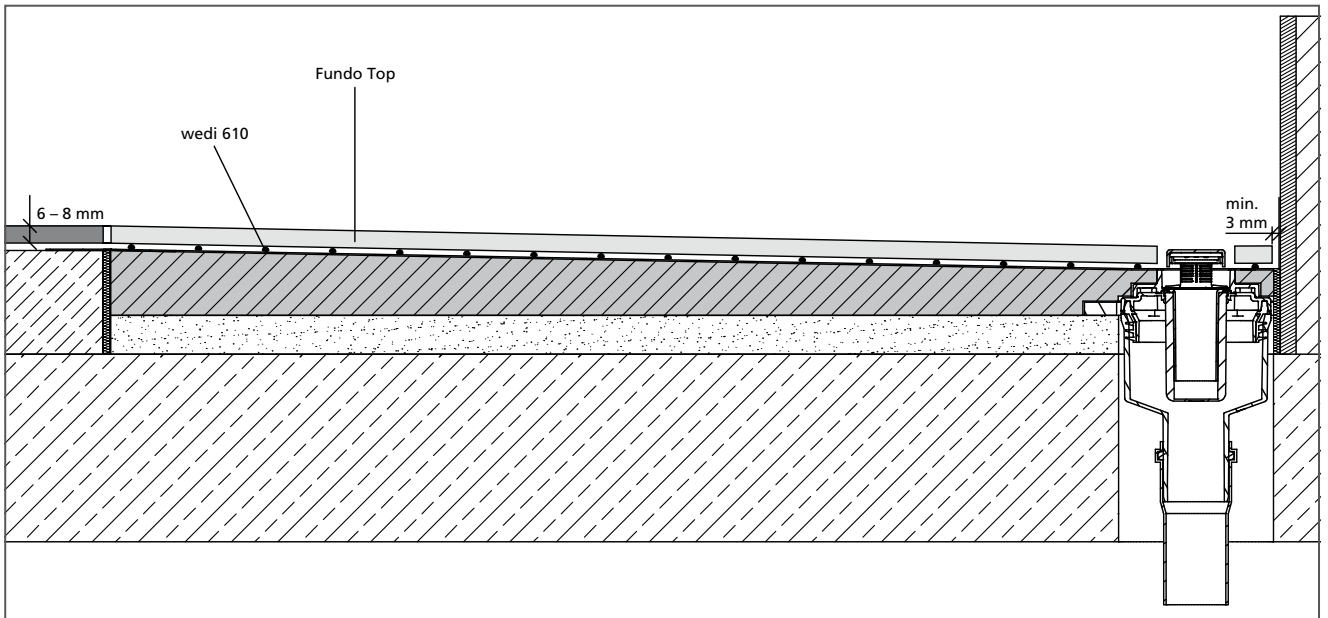
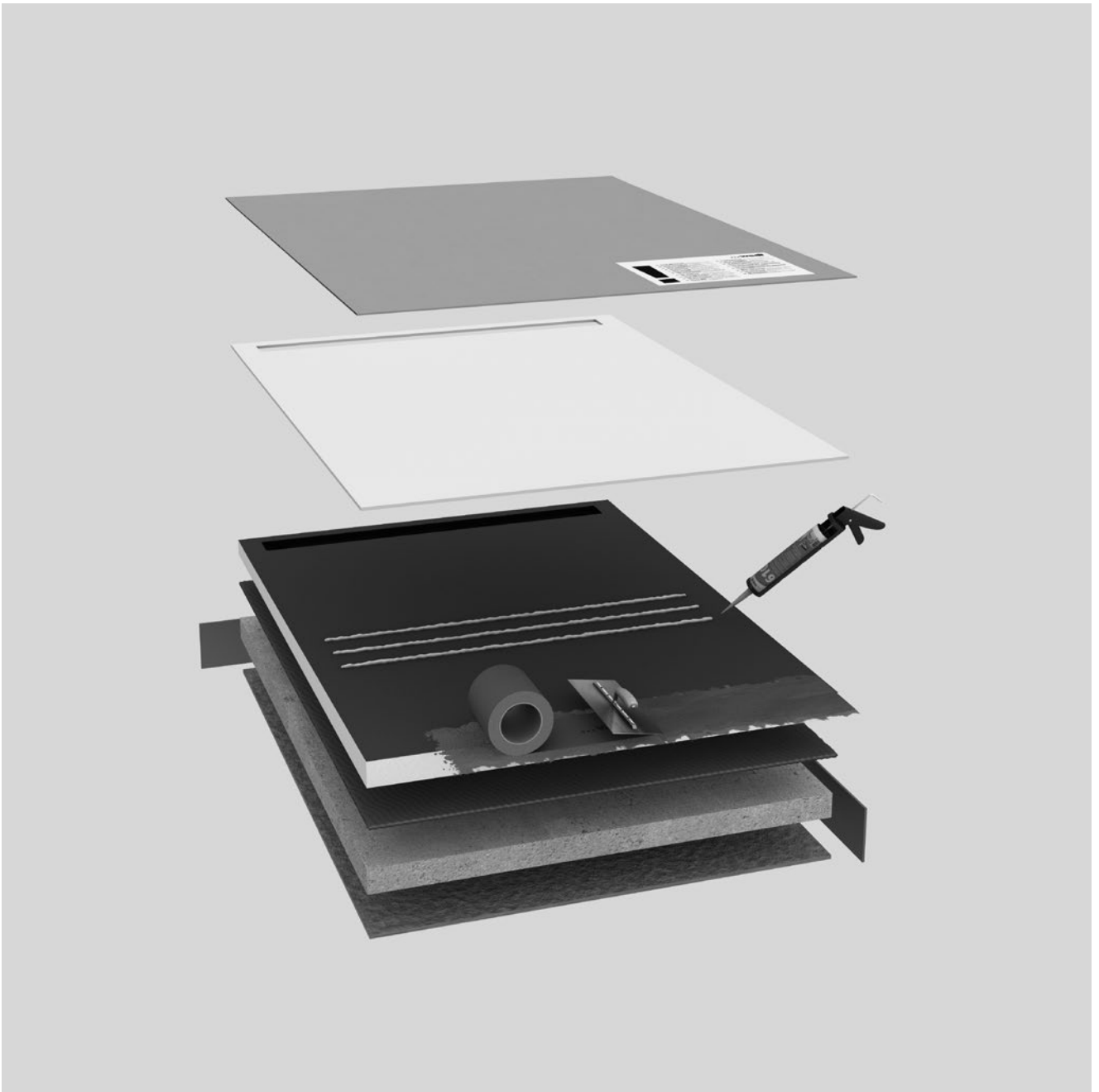

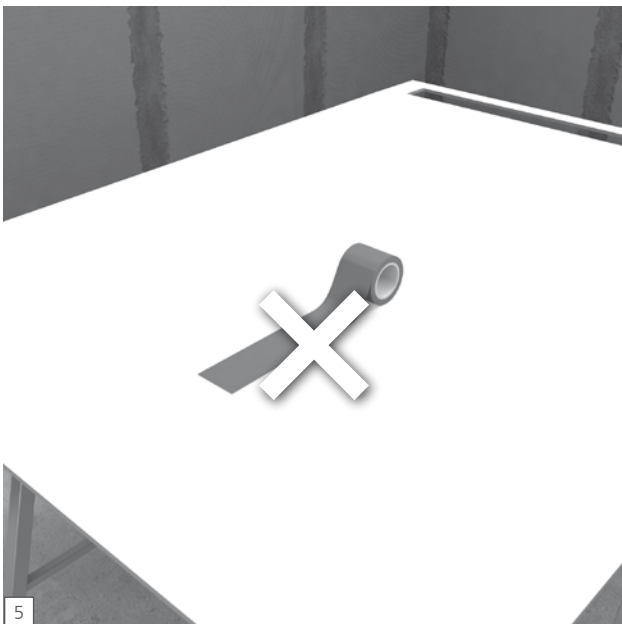
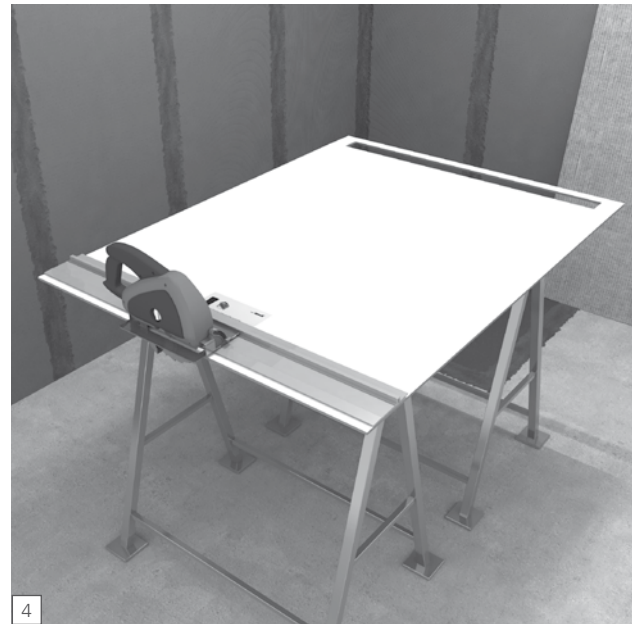
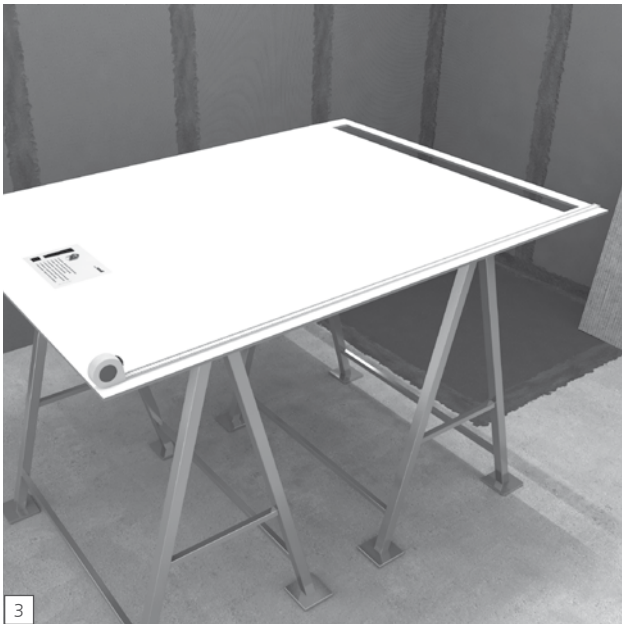
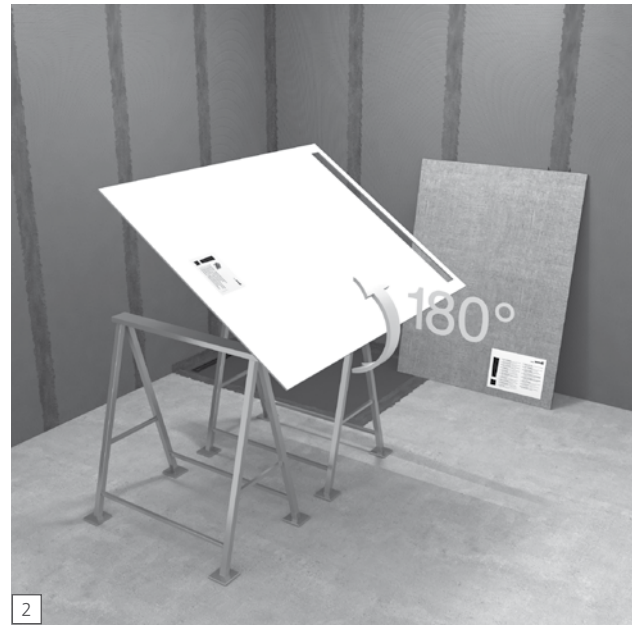
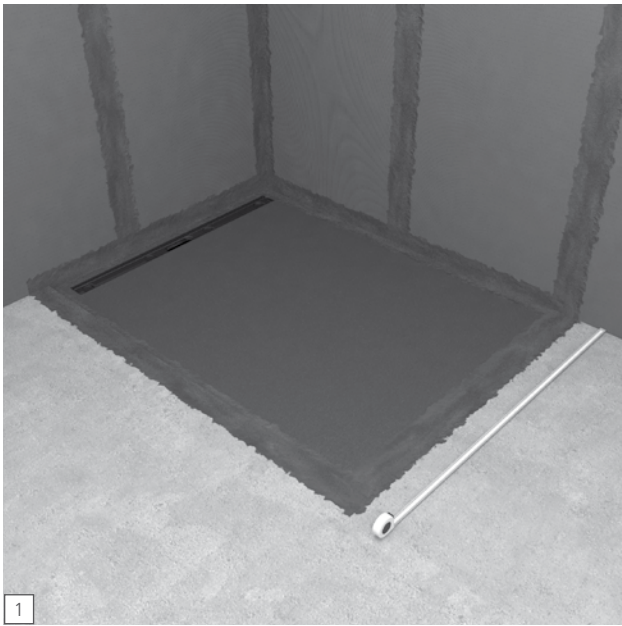

DE Nicht bekleben!

EN No sticking!

FR Ne rien coller !

ES ¡No pegar!

IT Non incollare!

NL Niet beplakken!

PL Nie oklejać!

PT Não efetuar colagens!

NO Må ikke limes på!

SE Får ej klistras över!

FI Ei päälleliimausta!

DK Må ikke overklæbes!

RU Не облицовывать!

GR Μη κολλάτε τίποτα επάνω!

HU Le-/ráragasztani tilos!

CZ Nepolepovat!

SI Ne prelepiti!

HR Ne oblijepiti!

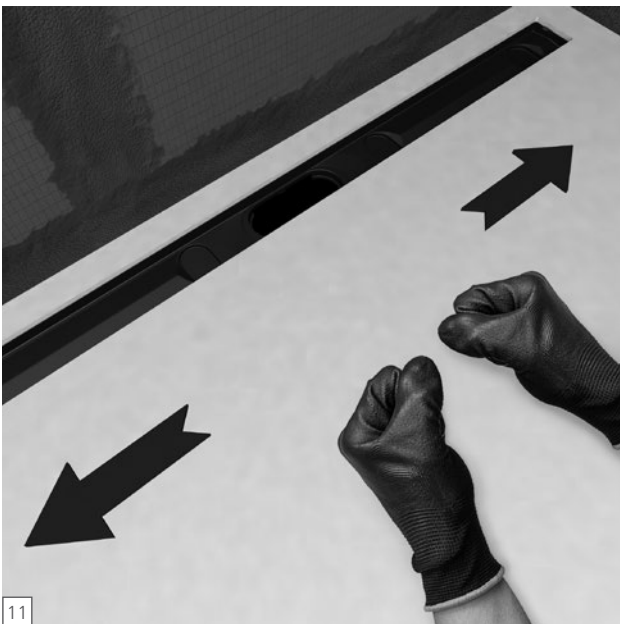
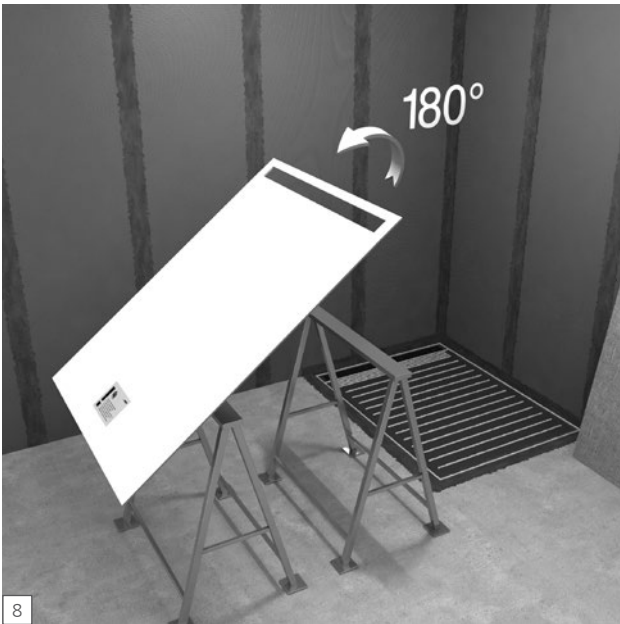
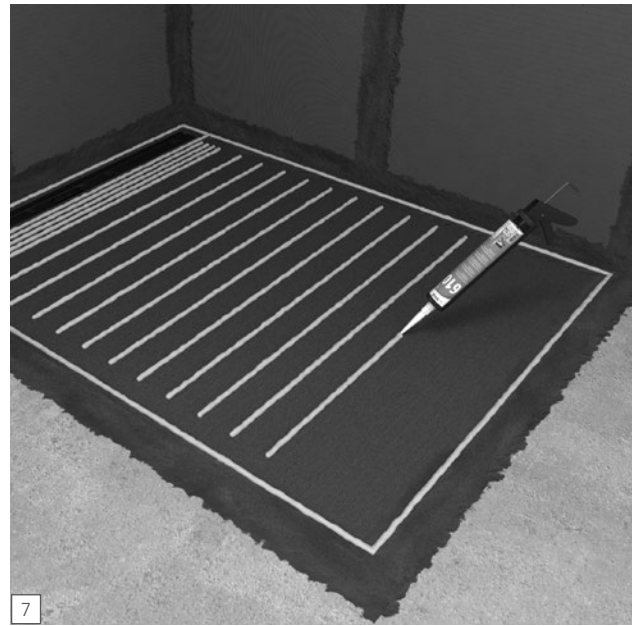

Presser et maroufler le revêtement Fundo Top de l'intérieur vers l'extérieur pour chasser l'air pris entre le revêtement Top et le receveur Riolito neo.

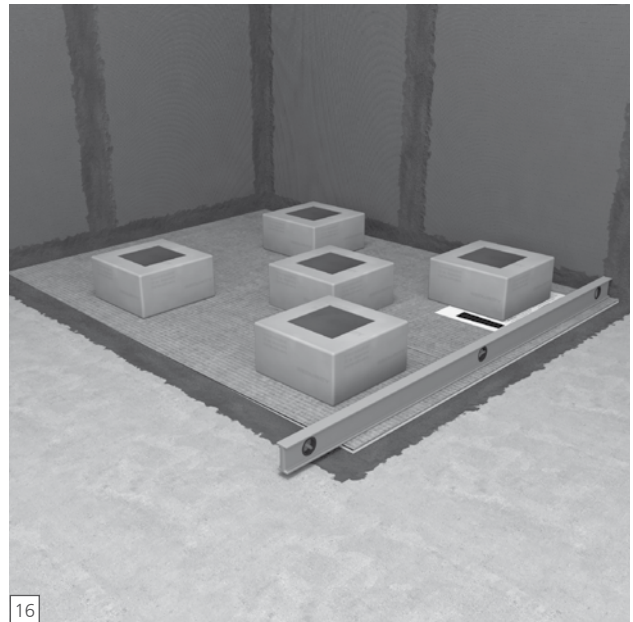
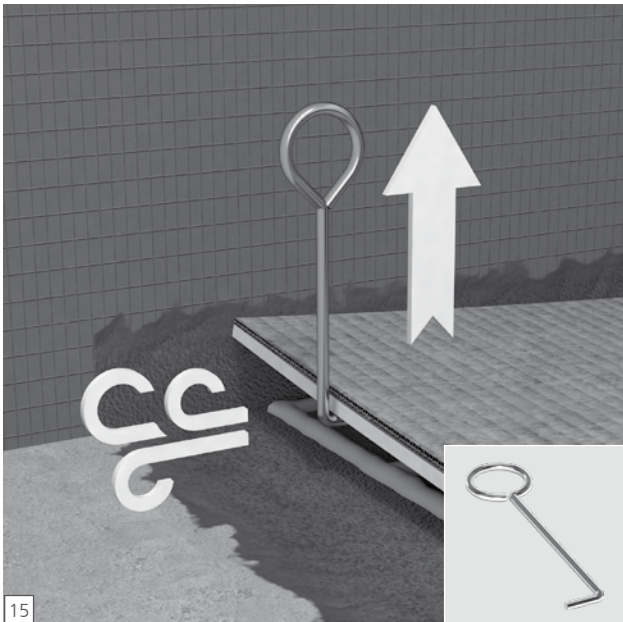
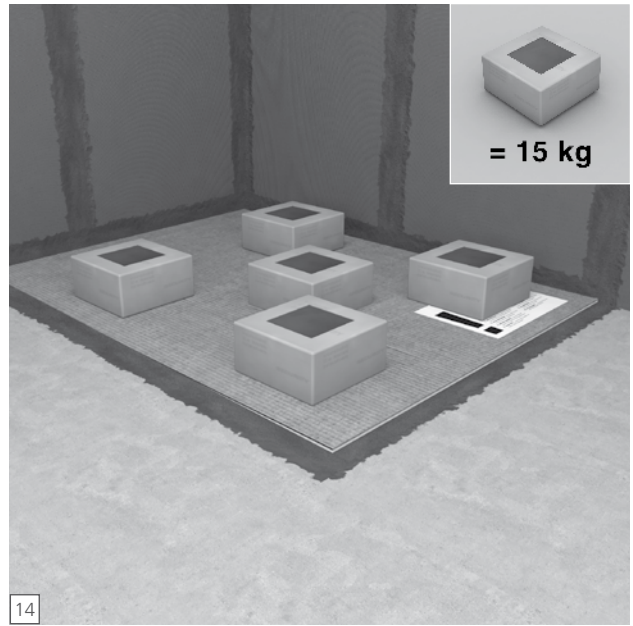
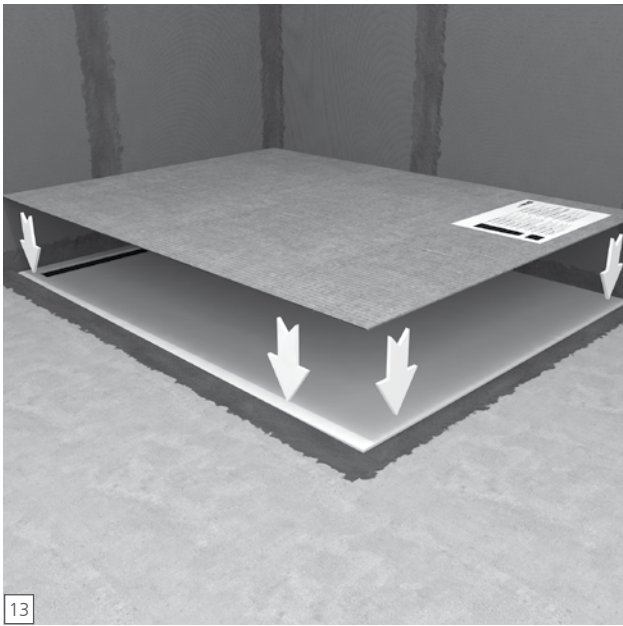

15 Chasser l'air lors du collage : se servir du crochet de tenue fourni, en pose finale du revêtement Top.

16 Bien appliquer les charges de maintien (5 x 15 kgs) pendant la durée du séchage (24 heures).

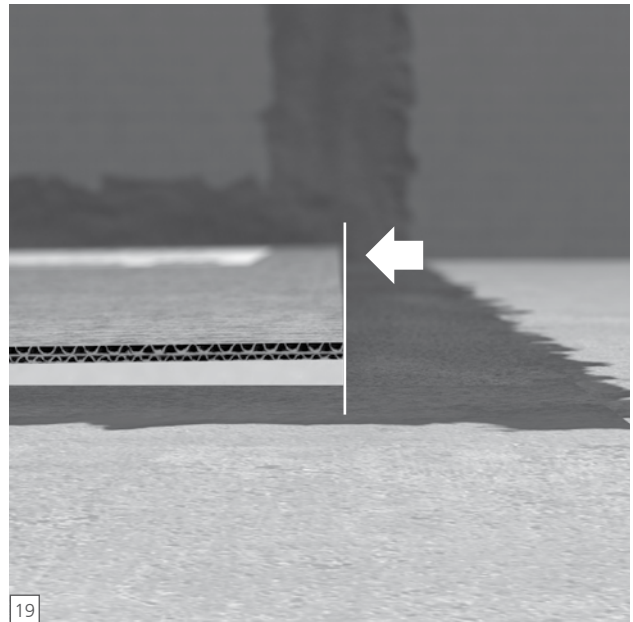
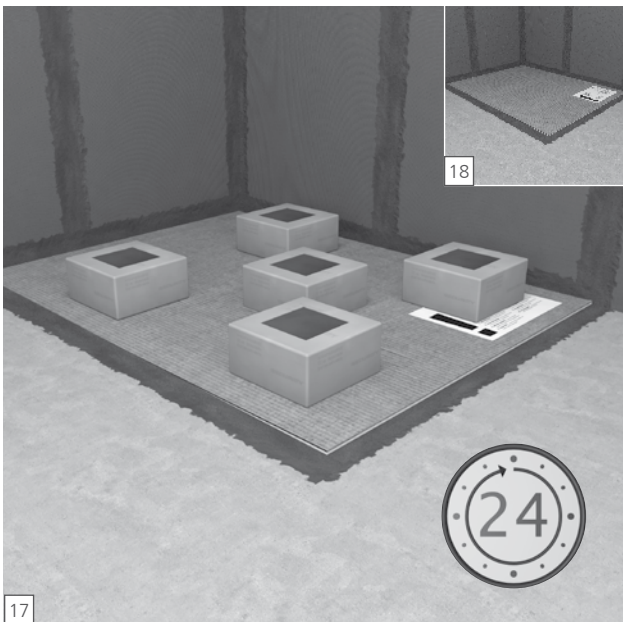

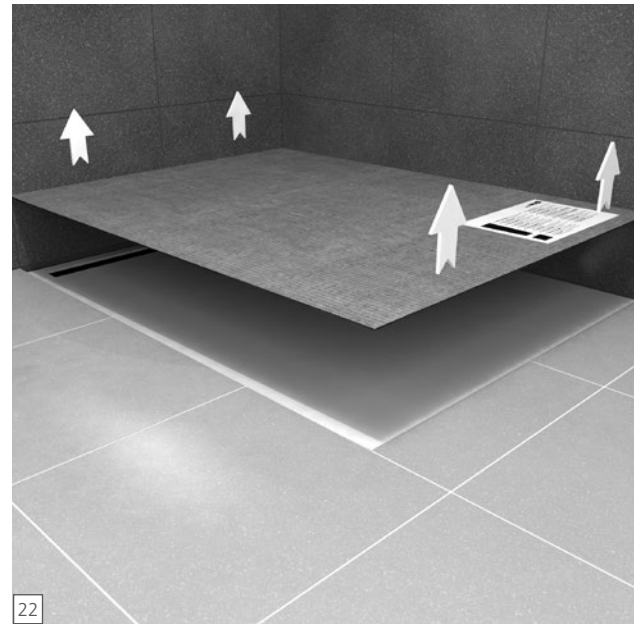
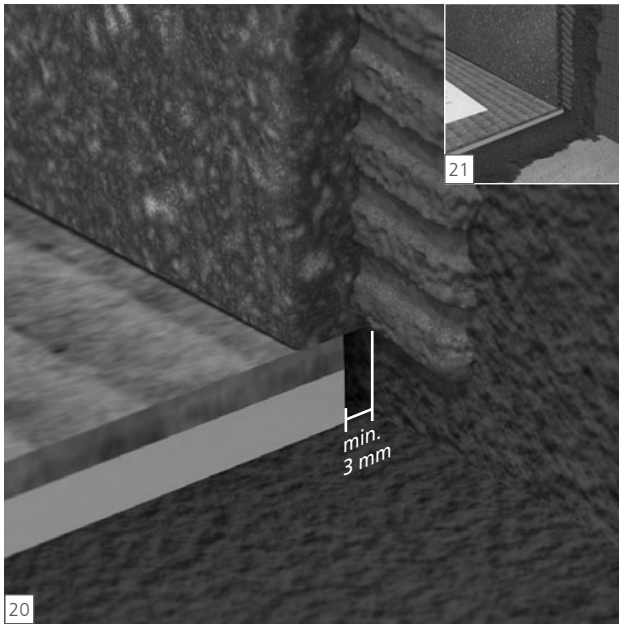

Veiller à bien ménager un espace de dilatation de 3 mm entre le revêtement Top et les parois latérales. Recouper le revêtement Top si nécessaire.



...wedi®

wedi GmbH
Hollefeldstraße 51
48282 Emsdetten
Deutschland

Telefon +49 2572 156-0
Telefax +49 2572 156-133

info@wedi.de
www.wedi.eu